



SERIE

P

CILINDRI COMPATTI ISO 21287
ISO 21287 COMPACT CYLINDERS

CARATTERISTICHE TECNICHE - TECHNICAL CHARACTERISTICS

Pressione di esercizio <i>Working pressure</i>	1 ÷ 10 bar (doppio effetto - <i>double acting</i>) 2 ÷ 10 bar (semplice effetto - <i>single acting</i>)
Temperatura di esercizio <i>Working temperature</i>	0 ÷ +80 °C (-20 °C con aria secca - <i>with dry air</i>) 0 ÷ +150 °C (con guarnizioni per alte temperature - <i>with high temperature seals</i>)
Versioni - Versions	semplice effetto - doppio effetto - antirotazione - stelo passante - tandem <i>single acting - double acting - anti-rotary - double rod - tandem</i>
Alesaggi - Bores	∅ 20 - 25 - 32 - 40 - 50 - 63 - 80 - 100 - 125
Corse - Strokes	vedere tabelle corse standard - <i>see standard stroke tables</i>
Fluido - Fluid	aria compressa filtrata, non lubrificata - <i>compressed filtered, non lubricated air</i>

CARATTERISTICHE COSTRUTTIVE - CONSTRUCTIVE CHARACTERISTICS

①	Stelo - Rod	acciaio inox AISI 303 - <i>stainless steel AISI 303</i>
②	Guarnizione stelo - Rod seal	poliuretano - <i>polyurethane</i>
③	Boccola - Bush	acciaio+PTFE - <i>steel+PTFE</i>
④ ⑬	Testate - Covers	alluminio pressofuso verniciato - <i>painted die cast aluminium</i>
⑤	O-ring	NBR
⑥	Tubo - Tube	alluminio anodizzato - <i>anodized aluminium</i>
⑦ ⑫	Paracolpo - Bumper	NBR (∅ 20 -25)
⑧	Pistone - Piston	alluminio - <i>aluminium</i>
⑨	Guarnizione pistone - Piston seal	NBR (∅ 20 -25) - PU (∅ 32 ÷ 125)
⑩	Pattino di guida - Guide ring	PBT+PTFE (∅ 20 -25)
⑪	Magnete - Magnet	plastroferrite - <i>rubber magnet</i>
	Viti - Screws	acciaio zincato - <i>zinc coated steel</i>
	Molla - Spring	acciaio - <i>steel</i>
	Dado stelo - Rod nut	acciaio zincato - <i>zinc coated steel</i>

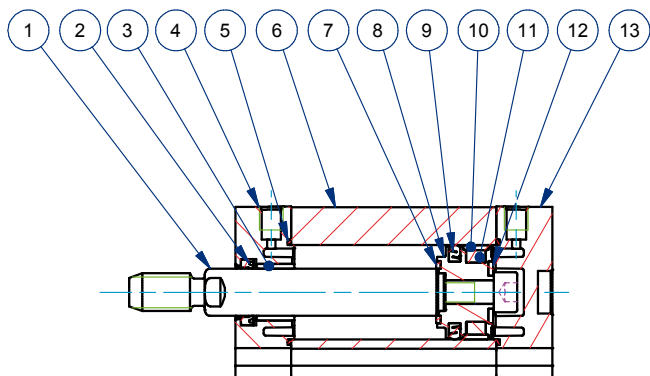

∅20 - ∅25

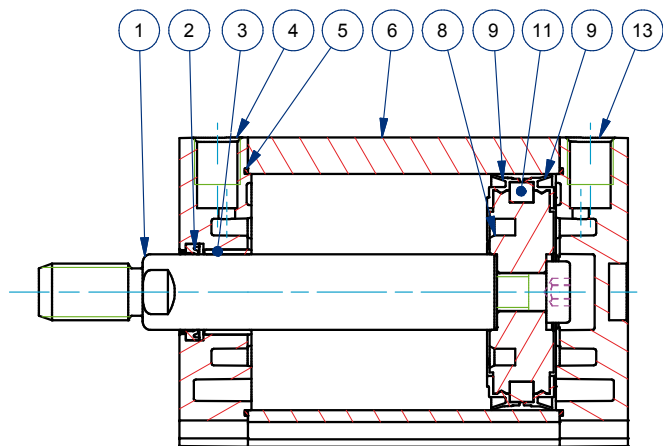

∅32 ÷ ∅125

CHIAVE DI CODIFICA

KEY CODE

P	D	M			0	5	0	.	0	3	0	.	G	S	.	F
					ALESAGGIO - BORE (Ø)		CORSA - STROKE (mm)						OPZIONE - OPTION			
					020 - 025 - 032 - 040 050 - 063 - 080 - 100 - 125		vedere tabelle corse std see std stroke tables						EX ATEX II 2GD c T4			
					VERSIONE - VERSION								OPZIONE - OPTION			
					A con staffa antirotazione with anti-rotation bracket								S viti inox SS screws			
					VERSIONE - VERSION								STELO - ROD			
					P stelo passante double rod								F femmina female			
					VERSIONE - VERSION								M maschio male			
					M magnetico magnetic								FT forato telescopico telescopic hollow rod			
					non magnetico non-magnetic								OPZIONE - OPTION			
					VERSIONE - VERSION								V femmina female			
					S semplice effetto molla anteriore single acting front spring								Z maschio male			
					SE semplice effetto molla posteriore single acting rear spring											
					D doppio effetto double acting											
					SERIE - SERIES											
					P tubo profilato con cave per sensori tube with slots for sensors											
													GUARNIZIONI - SEALS			
													guarnizioni standard standard seals GS			
													guarnizione stelo per alte temperature high temperature rod seal VR			
													tutte le guarnizioni per alte temperature all seals for high temperature VA			
													guarnizione stelo EU P5600 EU P5600 rod seal PS			
													guarnizione stelo E8 E8 rod seal ES			
													guarnizione stelo EW (raschiatore metallico) EW rod seal (metal scraper) WS			

Cilindri tandem vedi pagina 103
Tandem cylinders see page 103

ESECUZIONI A RICHIESTA - ON REQUEST

- Stelo forato - *Hollow rod*
- Stelo prolungato (WH) - *Extended rod (WH)*
- Filetti speciali (dado stelo non fornito) - *Special thread (without rod nut)*
- Viti in acciaio inox - *Stainless steel screws*
- ATEX II 2GD c T4

FORZE TEORICHE DI TRAZIONE (P=6 bar)

THEORETICAL FORCES OF TRACTION (P=6 bar)

		Ø	020	025	032	040	050	063	080	100	125
PDM	SPINTA THRUST	[N]	189	295	483	753	1.178	1.870	3.016	4.712	7.363
	TRAZIONE TRACTION	[N]	141	247	415	686	1.057	1.750	2.827	4.524	7.069
PDMA	SPINTA THRUST	[N]	189	295	483	753	1.178	1.870	3.016	4.712	7.363
	TRAZIONE TRACTION	[N]	141	247	415	686	1.057	1.750	2.827	4.524	7.069
PDMP	SPINTA THRUST	[N]	141	247	415	686	1.057	1.750	2.827	4.524	7.069
	TRAZIONE TRACTION	[N]	141	247	415	686	1.057	1.750	2.827	4.524	7.069
PDMPA	SPINTA THRUST	[N]	141	247	415	686	1.057	1.750	2.827	4.524	7.069
	TRAZIONE TRACTION	[N]	141	247	415	686	1.057	1.750	2.827	4.524	7.069

DIAGRAMMA TEORICO CARICO AMMISSIBILE

THEORETICAL ALLOWABLE LOAD

SERIE
P



DIAGRAMMA TEORICO CARICO AMMISSIBILE

THEORETICAL ALLOWABLE LOAD

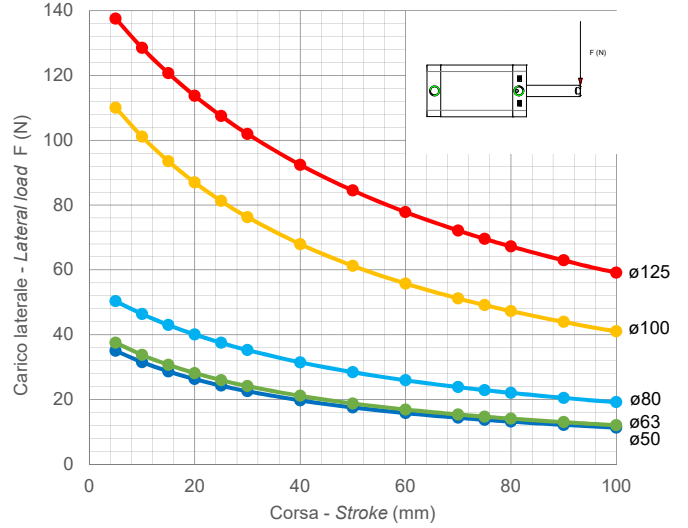
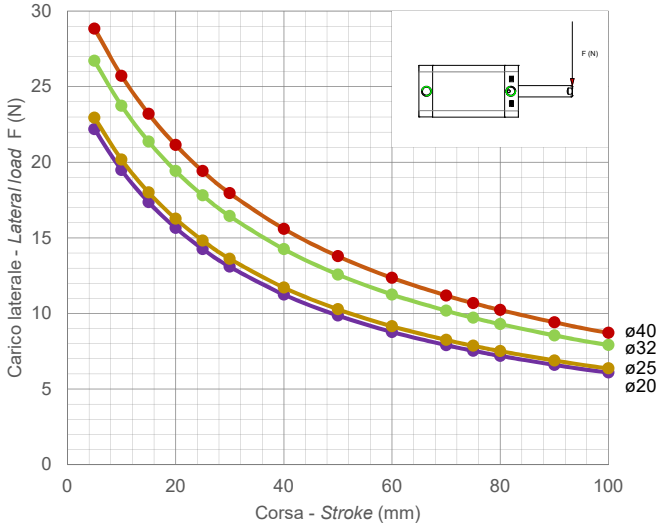

DIAGRAMMA TEORICO CARICO AMMISSIBILE

THEORETICAL ALLOWABLE LOAD

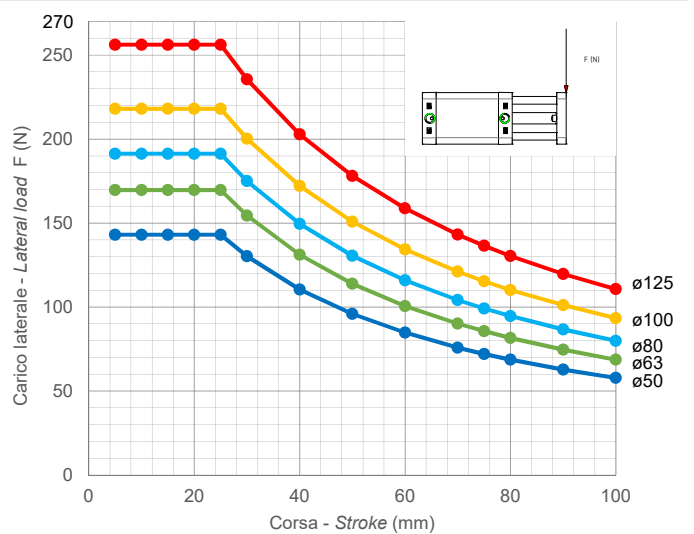
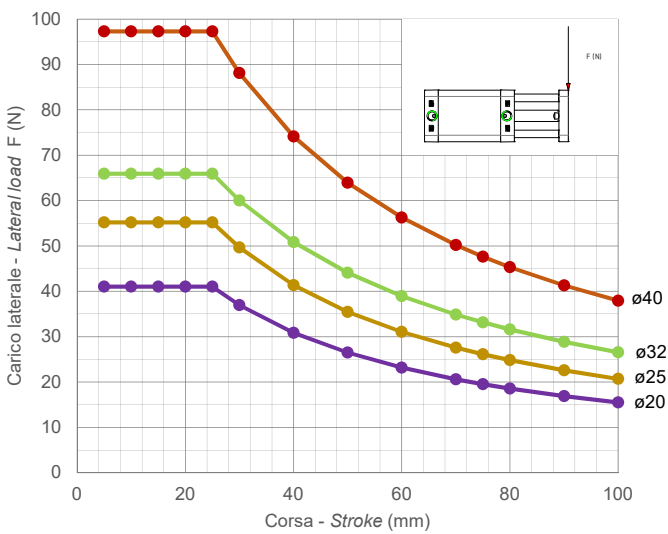
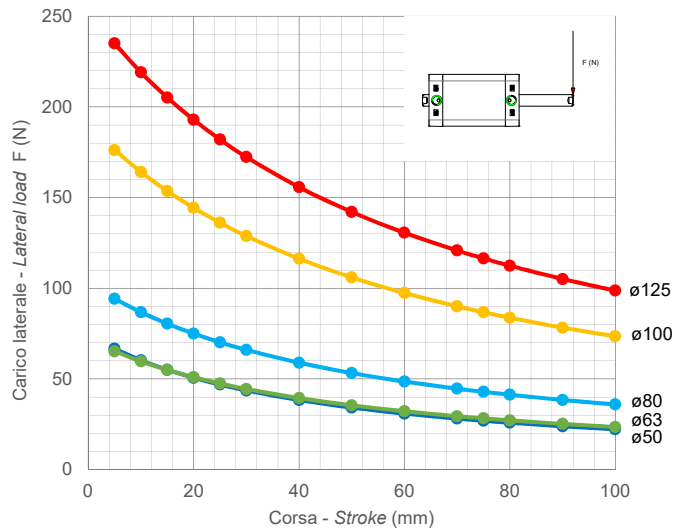
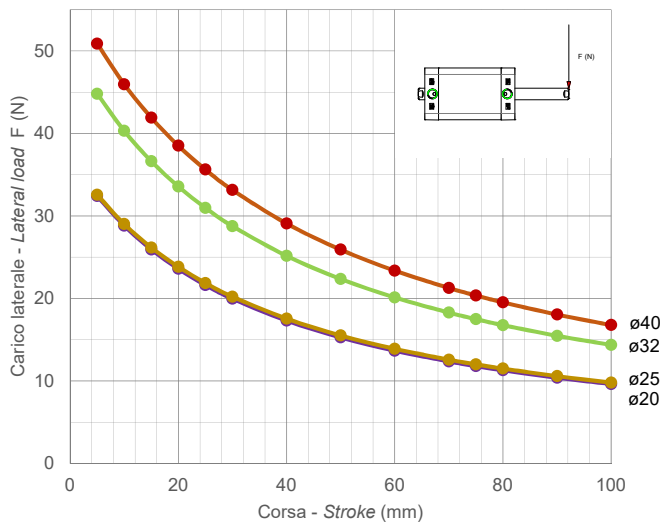

SERIE
P

DIAGRAMMA TEORICO COPPIA AMMISSIBILE

THEORETICAL ALLOWABLE TORQUE

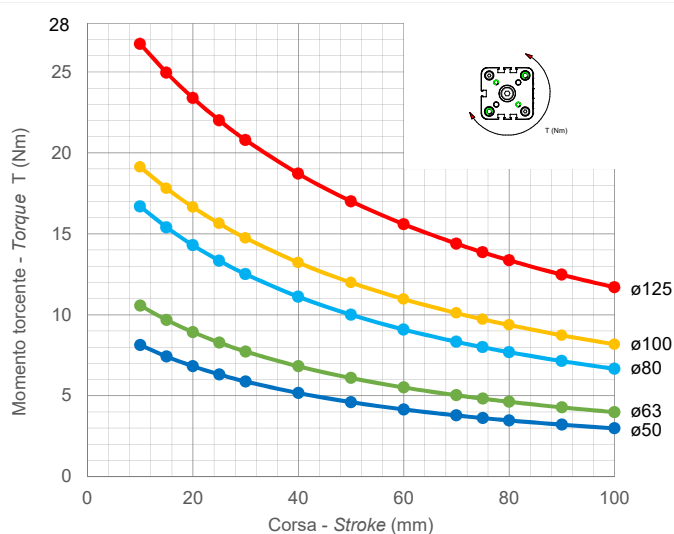
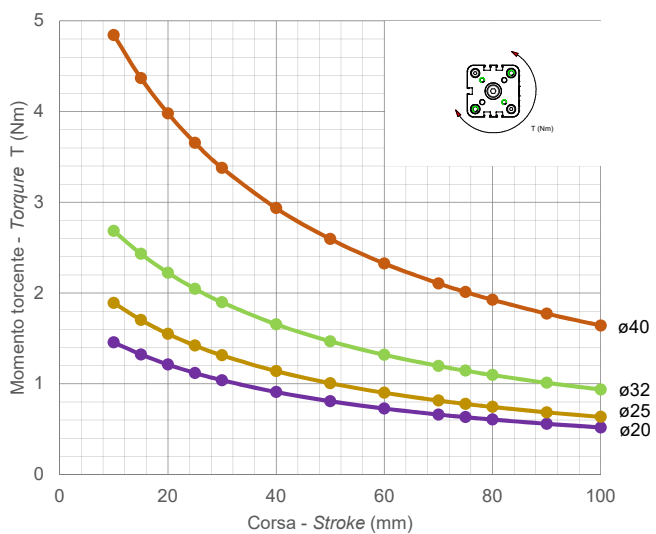

SEMPLICE EFFETTO MAGNETICO - MOLLA ANTERIORE

SINGLE ACTING MAGNETIC - FRONT SPRING

SERIE
P

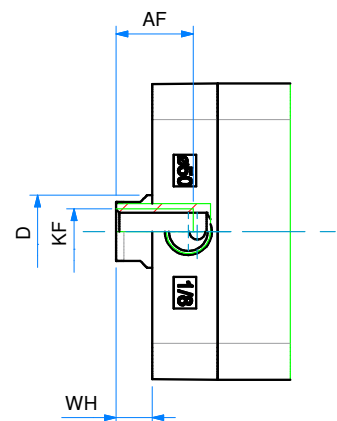
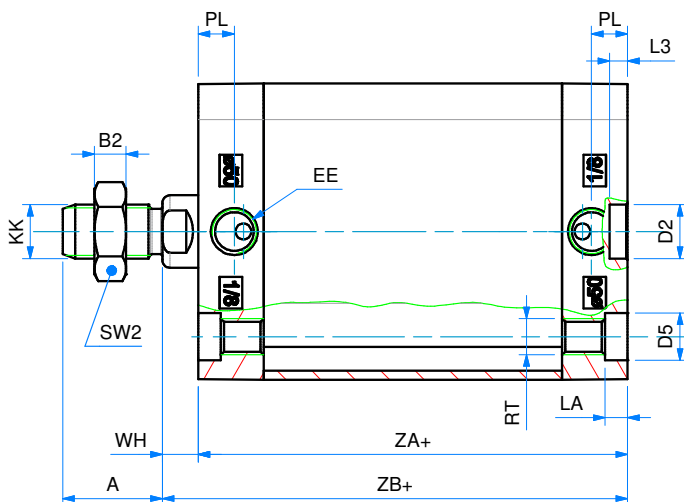
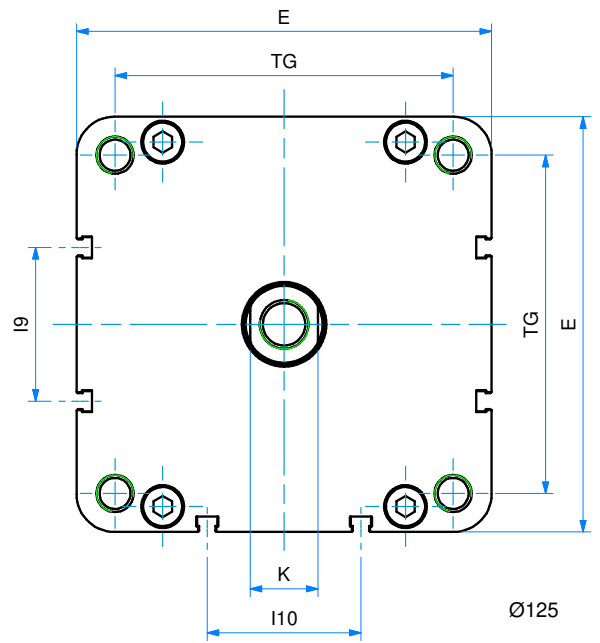
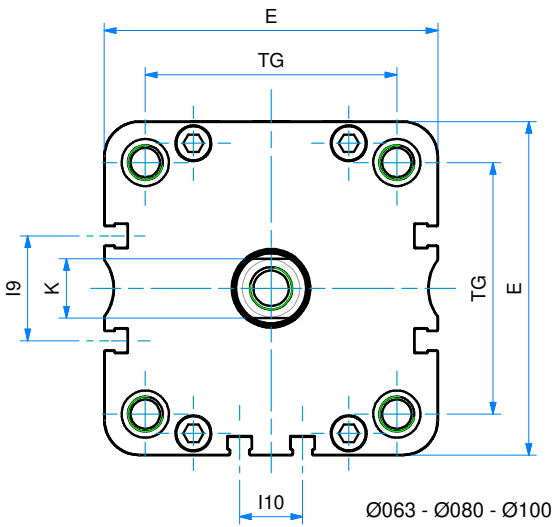
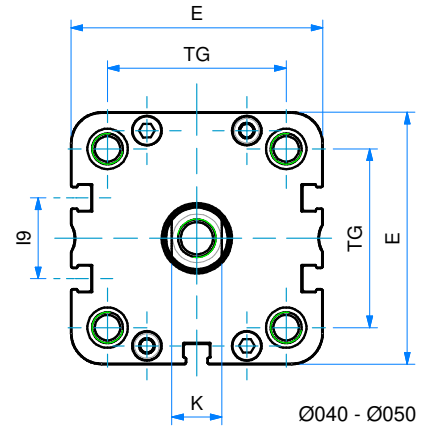
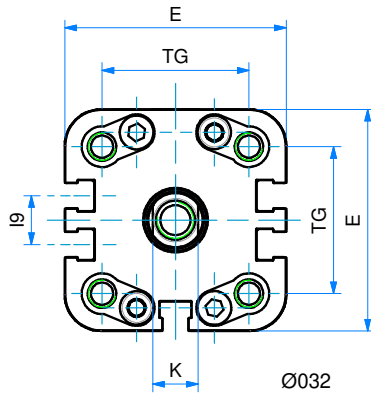
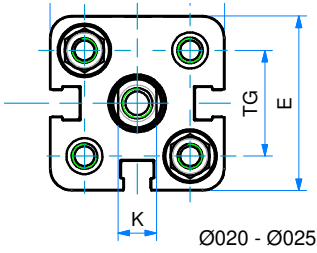
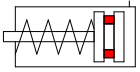
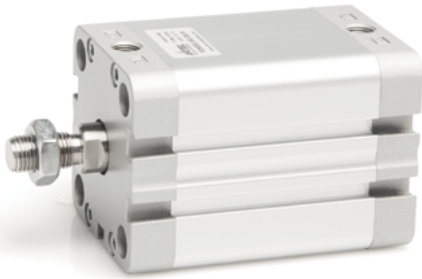

SEMPLICE EFFETTO MAGNETICO - MOLLA ANTERIORE
SINGLE ACTING MAGNETIC - FRONT SPRING
DIMENSIONI - DIMENSIONS

Ø	020	025	032	040	050	063	080	100	125
A	16	16	19	19	22	22	28	28	40
AF	15	15	15	15	17	17	20	22	25
B2	5	5	6	6	7	7	8	8	9
Ø D	10	10	12	12	16	16	20	25	25
Ø D2	9	9	9	9	12	12	12	12	12
Ø D5	7,5	7,5	9	9	10,5	10,5	13,5	13,5	13,5
E	36	40	49	54,5	65,5	77	95,5	113,5	135
EE	M5	M5	G1/8	G1/8	G1/8	G1/8	G1/8	G1/8	G1/4
I9	-	-	10,8	12,8	21	25,8	30	50	50
I 10	-	-	-	-	-	13	18	35	50
K	8	8	10	10	13	13	17	22	22
KF	M6	M6	M8	M8	M10	M10	M12	M12	M16
KK	M8	M8	M10x1,25	M10x1,25	M12x1,25	M12x1,25	M16x1,5	M16x1,5	M20x1,5
LA	4,5	4,5	5	5	5	5	3	3	-
L3	3	3	3	3	4	4	4	4	4
PL	7,5	7,5	7,5	8	8	7,5	8	10,5	10,5
RT	M5	M5	M6	M6	M8	M8	M10	M10	M12
SW2	13	13	17	17	19	19	24	24	30
TG	22	26	32,5	38	46,5	56,5	72	89	110
WH	6,5	6	6,5	7	8	8	9	10	11
ZA+	37*	39*	44*	45*	45*	49*	54*	67*	81
ZB+	43,5*	45*	50,5*	52*	53*	57*	63*	77*	92

+ = aggiungere lunghezza corsa (mm) - add stroke length (mm)

Note: dado stelo compreso nella fornitura
Note: rod nut included in the supply

* per corse - for strokes 035 - 040 - 050 - 060:

PSM 020 aggiungere - add +10 mm

PSM 025 - 032 - 040 - 050 - 063 aggiungere - add +20 mm

PSM 080 - 100 aggiungere - add +30 mm

Ø CORSE STANDARD - STANDARD STROKES

020	5 - 10 - 15 - 20 - 25 - 30 - 35 - 40 - 50 - 60
025	5 - 10 - 15 - 20 - 25 - 30 - 35 - 40 - 50 - 60
032	5 - 10 - 15 - 20 - 25 - 30 - 35 - 40 - 50 - 60
040	5 - 10 - 15 - 20 - 25 - 30 - 35 - 40 - 50 - 60
050	5 - 10 - 15 - 20 - 25 - 30 - 35 - 40 - 50 - 60
063	5 - 10 - 15 - 20 - 25 - 30 - 35 - 40 - 50 - 60
080	5 - 10 - 15 - 20 - 25 - 30 - 35 - 40 - 50 - 60
100	5 - 10 - 15 - 20 - 25 - 30 - 35 - 40 - 50 - 60
125	5 - 10 - 15 - 20 - 25 - 30

SEMPLICE EFFETTO MAGNETICO - MOLLA POSTERIORE

SINGLE ACTING MAGNETIC - REAR SPRING

SERIE

P

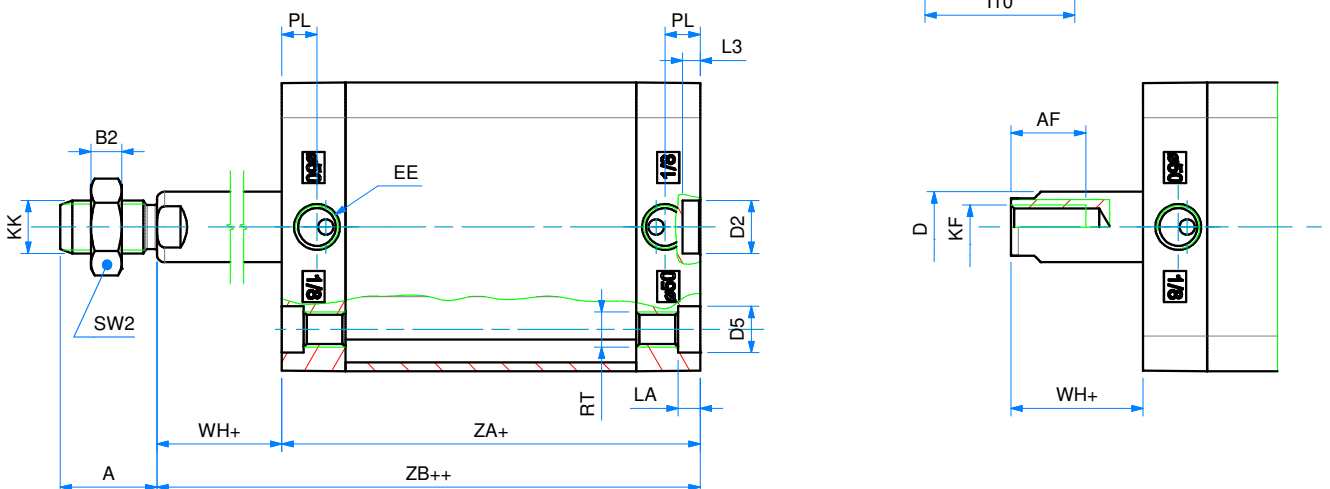
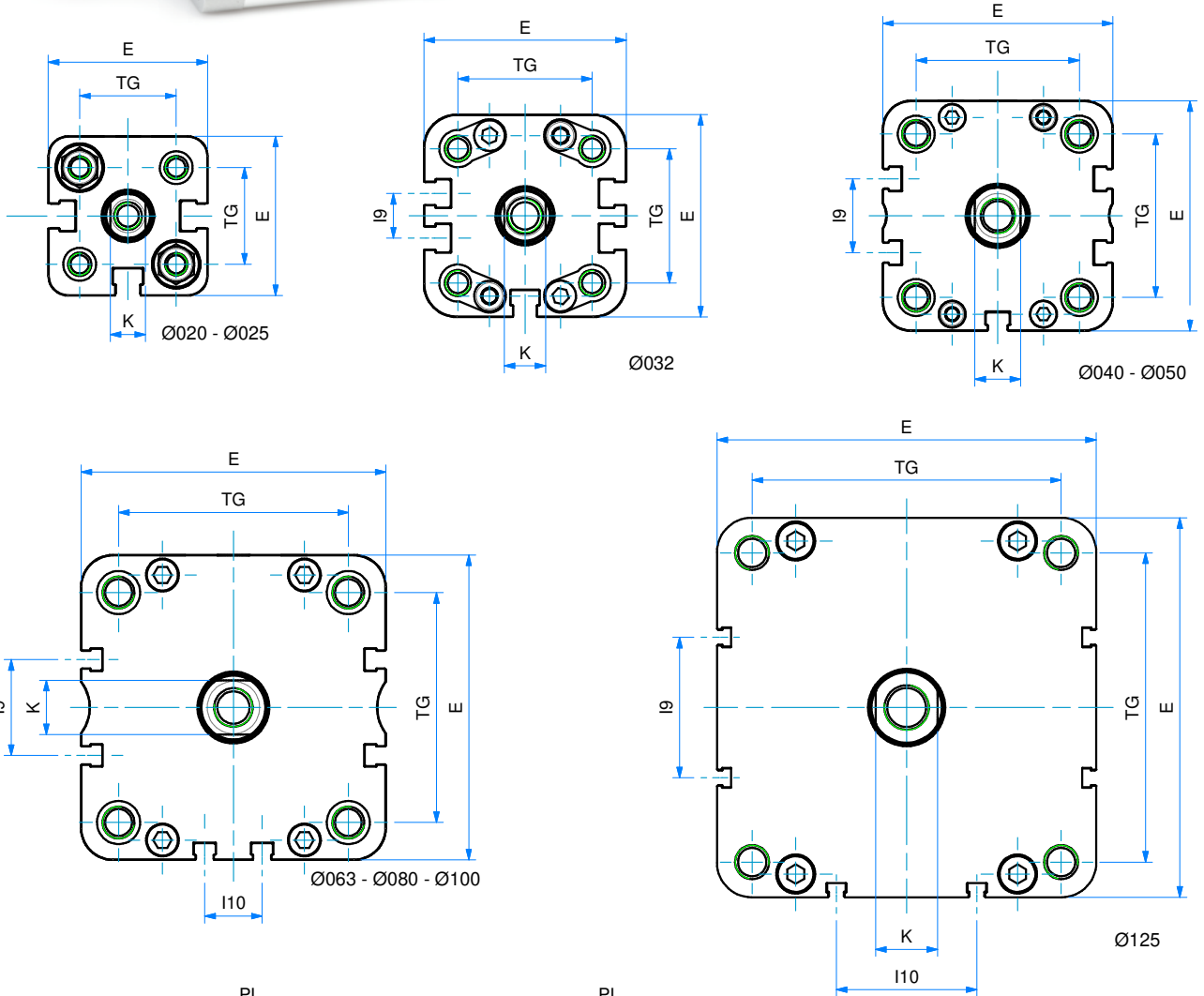
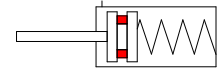
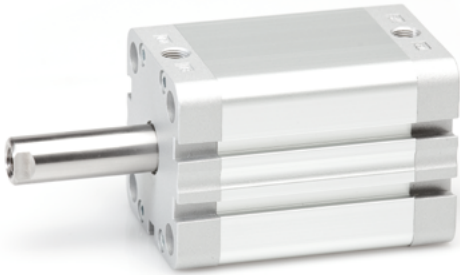

SEMPLICE EFFETTO MAGNETICO - MOLLA POSTERIORE
SINGLE ACTING MAGNETIC - REAR SPRING
DIMENSIONI - DIMENSIONS

Ø	020	025	032	040	050	063	080	100	125
A	16	16	19	19	22	22	28	28	40
AF	15	15	15	15	17	17	20	22	25
B2	5	5	6	6	7	7	8	8	9
Ø D	10	10	12	12	16	16	20	25	25
Ø D2	9	9	9	9	12	12	12	12	12
Ø D5	7,5	7,5	9	9	10,5	10,5	13,5	13,5	13,5
E	36	40	49	54,5	65,5	77	95,5	113,5	135
EE	M5	M5	G1/8	G1/8	G1/8	G1/8	G1/8	G1/8	G1/4
I9	-	-	10,8	12,8	21	25,8	30	50	50
I10	-	-	-	-	-	13	18	35	50
K	8	8	10	10	13	13	17	22	22
KF	M6	M6	M8	M8	M10	M10	M12	M12	M16
KK	M8	M8	M10x1,25	M10x1,25	M12x1,25	M12x1,25	M16x1,5	M16x1,5	M20x1,5
LA	4,5	4,5	5	5	5	5	3	3	-
L3	3	3	3	3	4	4	4	4	4
PL	7,5	7,5	7,5	8	8	7,5	8	10,5	10,5
RT	M5	M5	M6	M6	M8	M8	M10	M10	M12
SW2	13	13	17	17	19	19	24	24	30
TG	22	26	32,5	38	46,5	56,5	72	89	110
WH+	6,5	6	6,5	7	8	8	9	10	11
ZA+	37*	39*	44*	45*	45*	49*	54*	67*	81
ZB++	43,5*	45*	50,5*	52*	53*	57*	63*	77*	92

+ = aggiungere lunghezza corsa (mm) - add stroke length (mm)

++ = 2 x lunghezza corsa - 2 x stroke length

Note: dado stelo compreso nella fornitura

Note: rod nut included in the supply

* per corse - for strokes 035 - 040 - 050 - 060:

PSEM 020 - 025 - 032 - 040 - 050 - 063 aggiungere - add +10 mm

PSEM 080 - 100 aggiungere - add +20 mm

Ø CORSE STANDARD - STANDARD STROKES

020	5 - 10 - 15 - 20 - 25 - 30 - 35 - 40 - 50 - 60
025	5 - 10 - 15 - 20 - 25 - 30 - 35 - 40 - 50 - 60
032	5 - 10 - 15 - 20 - 25 - 30 - 35 - 40 - 50 - 60
040	5 - 10 - 15 - 20 - 25 - 30 - 35 - 40 - 50 - 60
050	5 - 10 - 15 - 20 - 25 - 30 - 35 - 40 - 50 - 60
063	5 - 10 - 15 - 20 - 25 - 30 - 35 - 40 - 50 - 60
080	5 - 10 - 15 - 20 - 25 - 30 - 35 - 40 - 50 - 60
100	5 - 10 - 15 - 20 - 25 - 30 - 35 - 40 - 50 - 60
125	5 - 10 - 15 - 20 - 25 - 30

DOPPIO EFFETTO MAGNETICO

DOUBLE ACTING MAGNETIC

SERIE
P

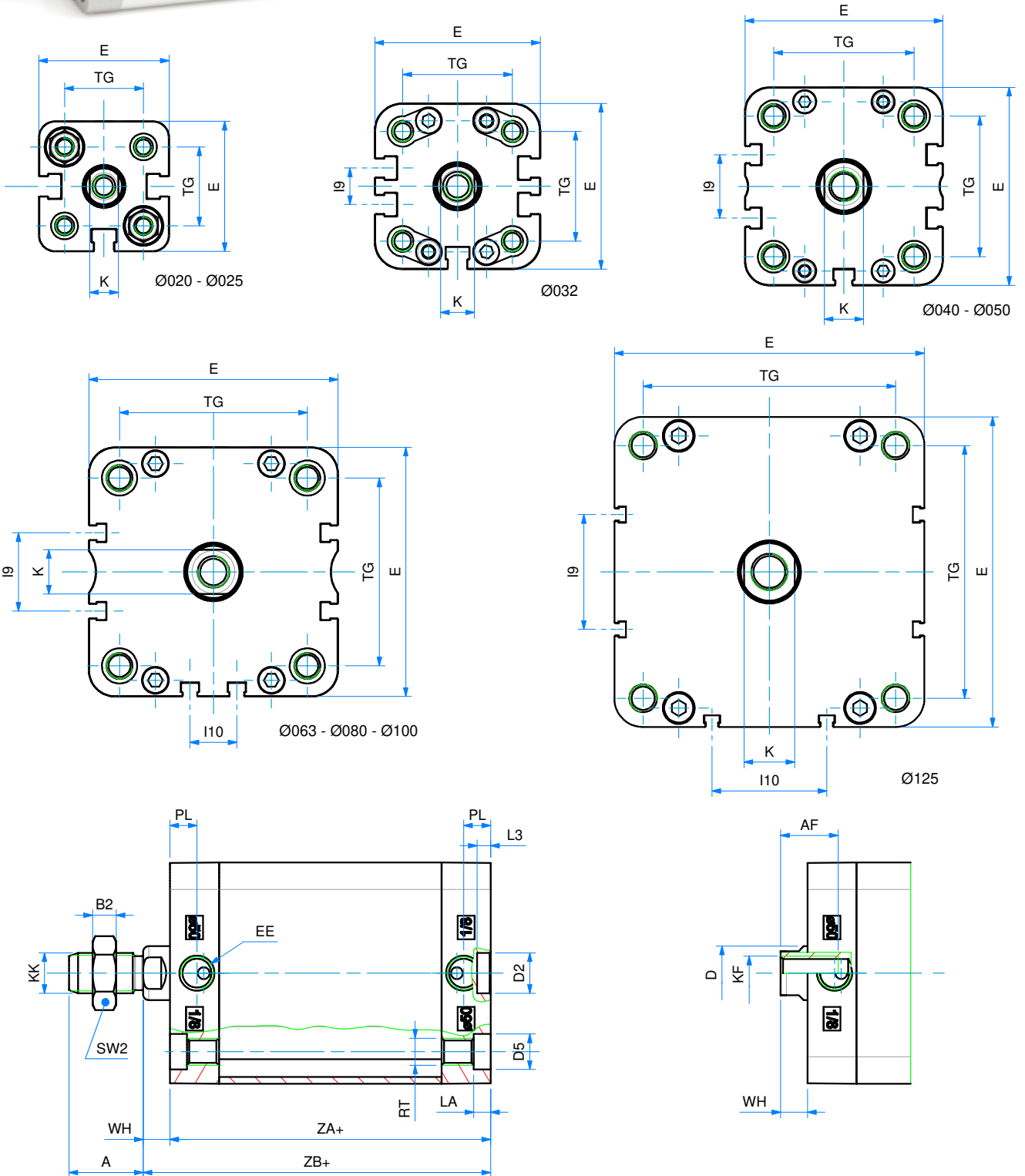
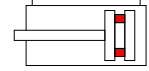

DOPPIO EFFETTO MAGNETICO
DOUBLE ACTING MAGNETIC
DIMENSIONI - DIMENSIONS

Ø	020	025	032	040	050	063	080	100	125
A	16	16	19	19	22	22	28	28	40
AF	15	15	15	15	17	17	20	22	25
B2	5	5	6	6	7	7	8	8	9
Ø D	10	10	12	12	16	16	20	25	25
Ø D2	9	9	9	9	12	12	12	12	12
Ø D5	7,5	7,5	9	9	10,5	10,5	13,5	13,5	-
E	36	40	49	54,5	65,5	77	95,5	113,5	135
EE	M5	M5	G1/8	G1/8	G1/8	G1/8	G1/8	G1/8	G1/4
I9	-	-	10,8	12,8	21	25,8	30	50	50
I10	-	-	-	-	-	13	18	35	50
K	8	8	10	10	13	13	17	22	22
KF	M6	M6	M8	M8	M10	M10	M12	M12	M16
KK	M8	M8	M10x1,25	M10x1,25	M12x1,25	M12x1,25	M16x1,5	M16x1,5	M 20x1,5
LA	4,5	4,5	5	5	5	5	3	3	-
L3	3	3	3	3	4	4	4	4	4
PL	7,5	7,5	7,5	8	8	7,5	8	10,5	10,5
RT	M5	M5	M6	M6	M8	M8	M10	M10	M12
SW2	13	13	17	17	19	19	24	24	30
TG	22	26	32,5	38	46,5	56,5	72	89	110
WH	6,5	6	6,5	7	8	8	9	10	11
ZA+	37	39	44	45	45	49	54	67	81
ZB+	43,5	45	50,5	52	53	57	63	77	92

+ = aggiungere lunghezza corsa (mm) - add stroke length (mm)

Note: dado stelo compreso nella fornitura
Note: rod nut included in the supply

OPZIONE V (FEMMINA) - Z (MASCIO) - OPTION V (FEMALE) - Z (MALE)

Ø	020	025	032	040	050	063	080	100
A	16	22	22	24	32	32	40	40
AF	12	12	15	15	20	20	22	22
Ø D	10	10	12	16	20	20	25	25
K	8	8	10	13	17	17	22	22
KF	M5	M6	M6	M6	M8	M8	M10	M12
KK	M8	M10x1,25	M10x1,25	M12x1,25	M16x1,5	M16x1,5	M20x1,5	M20x1,5

Ø CORSE STANDARD - STANDARD STROKES

020	5 - 10 - 15 - 20 - 25 - 30 - 40 - 50 - 60 - 70 - 75 - 80 - 90 - 100 - 125 - 160 - 200 - 250
025	5 - 10 - 15 - 20 - 25 - 30 - 40 - 50 - 60 - 70 - 75 - 80 - 90 - 100 - 125 - 160 - 200 - 250
032	5 - 10 - 15 - 20 - 25 - 30 - 40 - 50 - 60 - 70 - 75 - 80 - 90 - 100 - 125 - 160 - 200 - 250 - 300 - 350 - 400
040	5 - 10 - 15 - 20 - 25 - 30 - 40 - 50 - 60 - 70 - 75 - 80 - 90 - 100 - 125 - 160 - 200 - 250 - 300 - 350 - 400
050	5 - 10 - 15 - 20 - 25 - 30 - 40 - 50 - 60 - 70 - 75 - 80 - 90 - 100 - 125 - 160 - 200 - 250 - 300 - 350 - 400
063	5 - 10 - 15 - 20 - 25 - 30 - 40 - 50 - 60 - 70 - 75 - 80 - 90 - 100 - 125 - 160 - 200 - 250 - 300 - 350 - 400
080	5 - 10 - 15 - 20 - 25 - 30 - 40 - 50 - 60 - 70 - 75 - 80 - 90 - 100 - 125 - 160 - 200 - 250 - 300 - 350 - 400
100	5 - 10 - 15 - 20 - 25 - 30 - 40 - 50 - 60 - 70 - 75 - 80 - 90 - 100 - 125 - 160 - 200 - 250 - 300 - 350 - 400
125	5 - 10 - 15 - 20 - 25 - 30 - 40 - 50 - 60 - 70 - 75 - 80 - 90 - 100 - 125 - 160 - 200 - 250 - 300 - 350 - 400

DOPPIO EFFETTO MAGNETICO ANTIROTAZIONE

DOUBLE ACTING MAGNETIC ANTI-ROTATION

SERIE

P

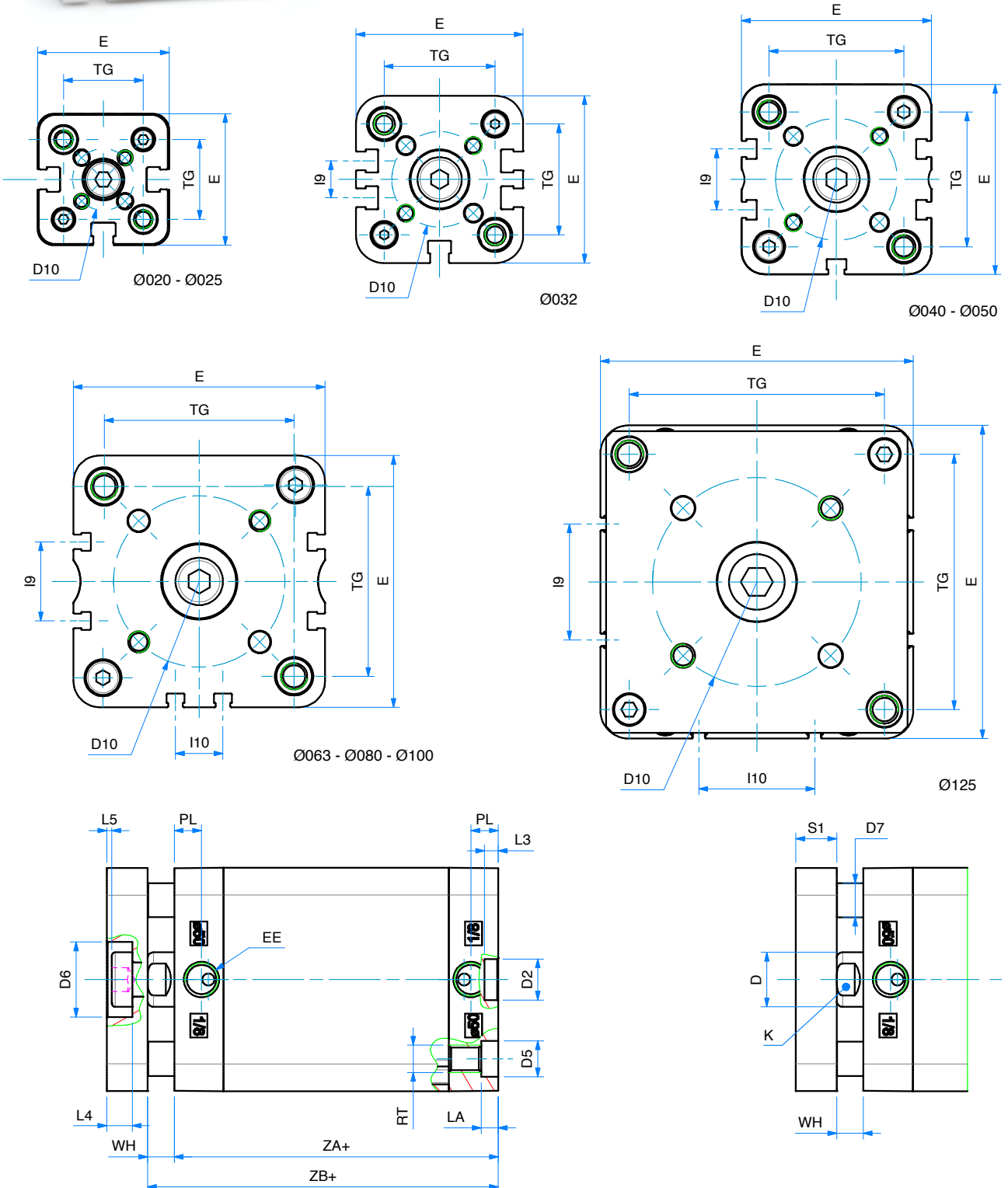
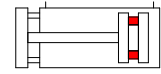

DOPPIO EFFETTO MAGNETICO ANTIROTAZIONE
DOUBLE ACTING MAGNETIC ANTI-ROTATION

DIMENSIONI - DIMENSIONS									
Ø	020	025	032	040	050	063	080	100	125
Ø D	10	10	12	12	16	16	20	25	25
Ø D2	9	9	9	9	12	12	12	12	12
Ø D5	7,5	7,5	9	9	10,5	10,5	13,5	13,5	13,5
Ø D6	11	14	17	17	22	22	28	30	34
Ø D7	5	6	6	8	10	10	14	14	14
D8	M4	M5	M5	M5	M6	M6	M8	M10	M10
Ø D9	4	5	5	5	6	6	8	10	10
Ø D10	17	22	28	33	42	50	65	80	90
E	36	40	49	54,5	65,5	77	95,5	113,5	135
EE	M5	M5	G1/8	G1/8	G1/8	G1/8	G1/8	G1/8	G1/4
I9	-	-	10,8	12,8	21	25,8	30	50	50
I10	-	-	-	-	-	13	18	35	50
K	8	8	10	10	13	13	17	22	22
LA	4,5	4,5	5	5	5	5	3	3	-
L3	3	3	3	3	4	4	4	4	4
L4	5	5	6,5	6,5	7,5	7,5	9	10	11,2
L5	1	1	1,5	1,5	1,5	1,5	2	3	2,2
PL	7,5	7,5	7,5	8	8	7,5	8	10,5	10,5
RT	M5	M5	M6	M6	M8	M8	M10	M10	M12
S1	8	8	10	10	12	12	14	14	18
TG	22	26	32,5	38	46,5	56,5	72	89	110
WH	6,5	6	6,5	7	8	8	9	10	11
ZA+	37	39	44	45	45	49	54	67	81
ZB+	43,5	45	50,5	52	53	57	63	77	92

+ = aggiungere lunghezza corsa (mm) - add stroke length (mm)

 Note: dado stelo compreso nella fornitura
 Note: rod nut included in the supply

Ø	CORSE STANDARD - STANDARD STROKES
020	5 - 10 - 15 - 20 - 25 - 30 - 40 - 50 - 60 - 70 - 75 - 80 - 90 - 100 - 125 - 160 - 200
025	5 - 10 - 15 - 20 - 25 - 30 - 40 - 50 - 60 - 70 - 75 - 80 - 90 - 100 - 125 - 160 - 200
032	5 - 10 - 15 - 20 - 25 - 30 - 40 - 50 - 60 - 70 - 75 - 80 - 90 - 100 - 125 - 160 - 200 - 250 - 300 - 350 - 400
040	5 - 10 - 15 - 20 - 25 - 30 - 40 - 50 - 60 - 70 - 75 - 80 - 90 - 100 - 125 - 160 - 200 - 250 - 300 - 350 - 400
050	5 - 10 - 15 - 20 - 25 - 30 - 40 - 50 - 60 - 70 - 75 - 80 - 90 - 100 - 125 - 160 - 200 - 250 - 300 - 350 - 400
063	5 - 10 - 15 - 20 - 25 - 30 - 40 - 50 - 60 - 70 - 75 - 80 - 90 - 100 - 125 - 160 - 200 - 250 - 300 - 350 - 400
080	5 - 10 - 15 - 20 - 25 - 30 - 40 - 50 - 60 - 70 - 75 - 80 - 90 - 100 - 125 - 160 - 200 - 250 - 300 - 350 - 400
100	5 - 10 - 15 - 20 - 25 - 30 - 40 - 50 - 60 - 70 - 75 - 80 - 90 - 100 - 125 - 160 - 200 - 250 - 300 - 350 - 400
125	5 - 10 - 15 - 20 - 25 - 30 - 40 - 50 - 60 - 70 - 75 - 80 - 90 - 100 - 125 - 160 - 200 - 250 - 300 - 350 - 400

DOPPIO EFFETTO MAGNETICO STELO PASSANTE

DOUBLE ACTING MAGNETIC WITH DOUBLE ROD

SERIE
P

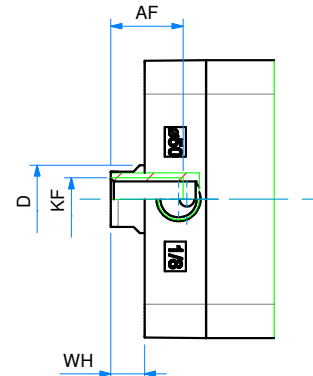
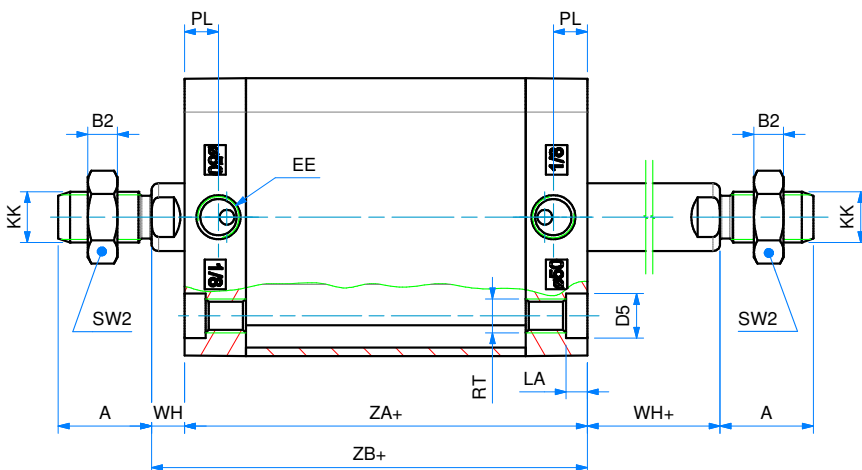
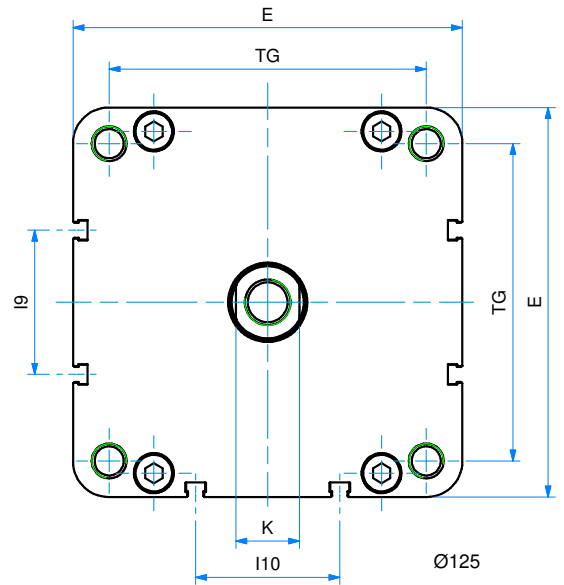
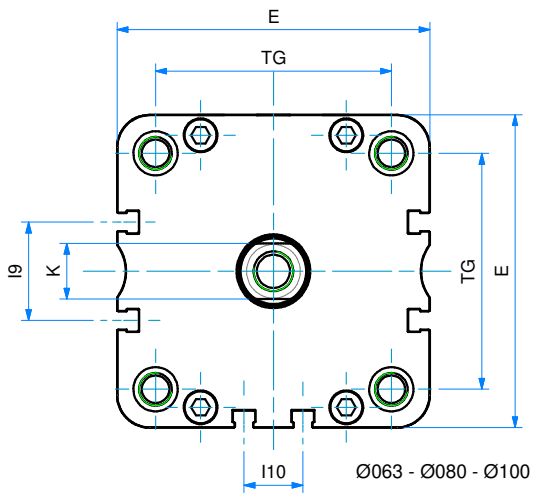
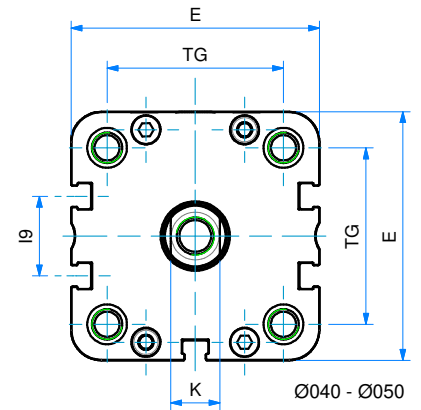
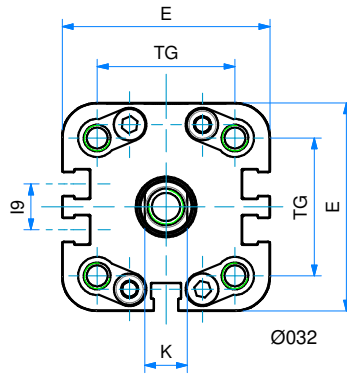
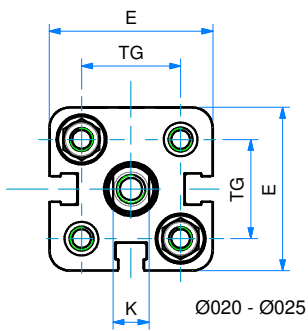
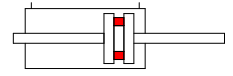
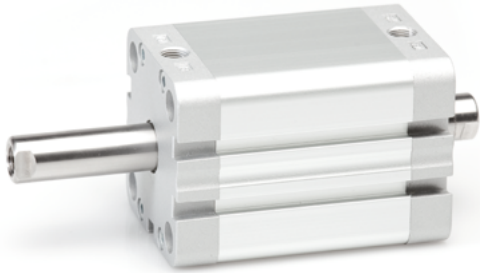

DOPPIO EFFETTO MAGNETICO STELO PASSANTE
DOUBLE ACTING MAGNETIC WITH DOUBLE ROD

DIMENSIONI - DIMENSIONS									
Ø	020	025	032	040	050	063	080	100	125
A	16	16	19	19	22	22	28	28	40
AF	15	15	15	15	17	17	20	22	25
B2	5	5	6	6	7	7	8	8	9
Ø D	10	10	12	12	16	16	20	25	25
Ø D5	7,5	7,5	9	9	10,5	10,5	13,5	13,5	-
E	36	40	49	54,5	65,5	77	95,5	113,5	135
EE	M5	M5	G1/8	G1/8	G1/8	G1/8	G1/8	G1/8	G1/4
I9	-	-	10,8	12,8	21	25,8	30	50	50
I10	-	-	-	-	-	13	18	35	50
K	8	8	10	10	13	13	17	22	22
KF	M6	M6	M8	M8	M10	M10	M12	M12	M16
KK	M8	M8	M10x1,25	M10x1,25	M12x1,25	M12x1,25	M16x1,5	M16x1,5	M20x1,5
LA	4,5	4,5	5	5	5	5	3	3	-
PL	7,5	7,5	7,5	8	8	7,5	8	10,5	10,5
RT	M5	M5	M6	M6	M8	M8	M10	M10	M12
SW2	13	13	17	17	19	19	24	24	30
TG	22	26	32,5	38	46,5	56,5	72	89	110
WH	6,5	6	6,5	7	8	8	9	10	11
WH+	6,5	6	6,5	7	8	8	9	10	11
ZA+	37	39	44	45	45	49	54	67	81
ZB+	43,5	45	50,5	52	53	57	63	77	92

+ = aggiungere lunghezza corsa (mm) - add stroke length (mm)

 Note: dado stelo compreso nella fornitura
 Note: rod nut included in the supply

OPZIONE V (FEMMINA) - Z (MASCIO) - OPTION V (FEMALE) - Z (MALE)									
Ø	020	025	032	040	050	063	080	100	
A	16	22	22	24	32	32	40	40	
AF	11	15	15	15	16	16	17	20	
Ø D	10	10	12	16	20	20	25	25	
K	8	8	10	13	17	17	22	22	
KF	M5	M6	M6	M6	M8	M8	M10	M12	
KK	M8	M10x1,25	M10x1,25	M12x1,25	M16x1,5	M16x1,5	M20x1,5	M20x1,5	

Ø CORSE STANDARD - STANDARD STROKES									
020	5 - 10 - 15 - 20 - 25 - 30 - 40 - 50 - 60 - 70 - 75 - 80 - 90 - 100 - 125 - 160 - 200 - 250								
025	5 - 10 - 15 - 20 - 25 - 30 - 40 - 50 - 60 - 70 - 75 - 80 - 90 - 100 - 125 - 160 - 200 - 250								
032	5 - 10 - 15 - 20 - 25 - 30 - 40 - 50 - 60 - 70 - 75 - 80 - 90 - 100 - 125 - 160 - 200 - 250 - 300 - 350 - 400								
040	5 - 10 - 15 - 20 - 25 - 30 - 40 - 50 - 60 - 70 - 75 - 80 - 90 - 100 - 125 - 160 - 200 - 250 - 300 - 350 - 400								
050	5 - 10 - 15 - 20 - 25 - 30 - 40 - 50 - 60 - 70 - 75 - 80 - 90 - 100 - 125 - 160 - 200 - 250 - 300 - 350 - 400								
063	5 - 10 - 15 - 20 - 25 - 30 - 40 - 50 - 60 - 70 - 75 - 80 - 90 - 100 - 125 - 160 - 200 - 250 - 300 - 350 - 400								
080	5 - 10 - 15 - 20 - 25 - 30 - 40 - 50 - 60 - 70 - 75 - 80 - 90 - 100 - 125 - 160 - 200 - 250 - 300 - 350 - 400								
100	5 - 10 - 15 - 20 - 25 - 30 - 40 - 50 - 60 - 70 - 75 - 80 - 90 - 100 - 125 - 160 - 200 - 250 - 300 - 350 - 400								
125	5 - 10 - 15 - 20 - 25 - 30 - 40 - 50 - 60 - 70 - 75 - 80 - 90 - 100 - 125 - 160 - 200 - 250 - 300 - 350 - 400								

DOPPIO EFFETTO MAGNETICO STELO PASSANTE ANTIROTAZIONE

DOUBLE ACTING MAGNETIC ANTI-ROTATION WITH DOUBLE ROD

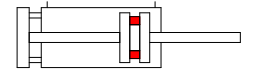

SERIE

P

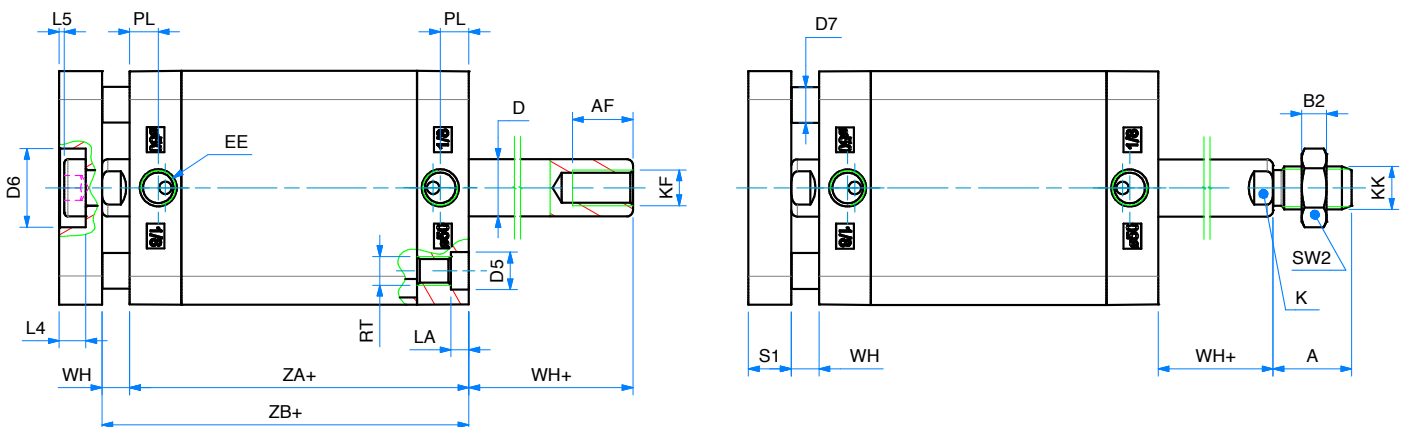
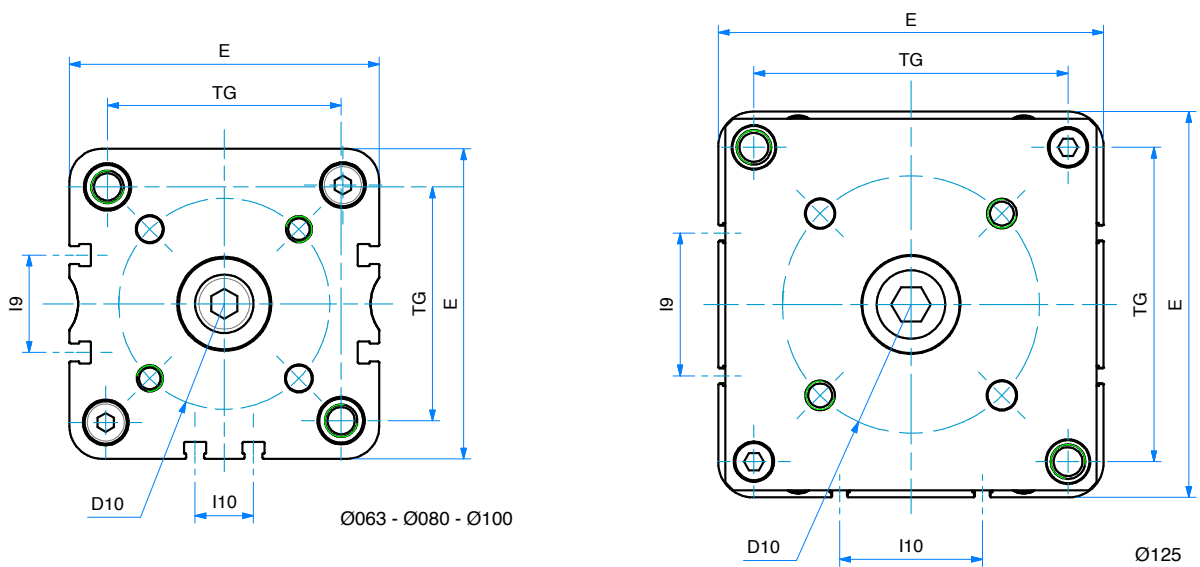
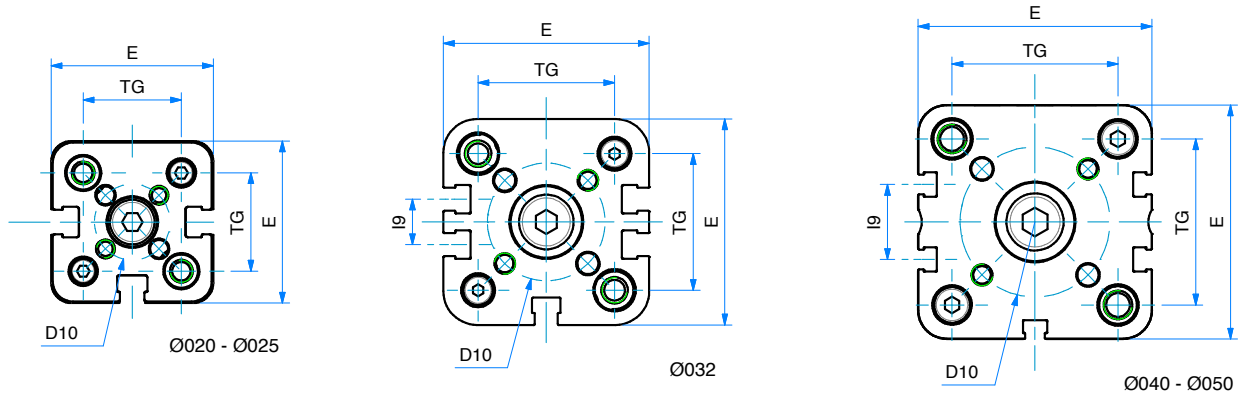
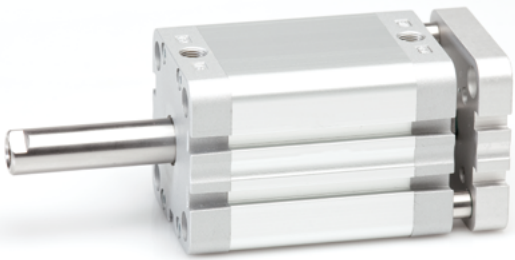

DOPPIO EFFETTO MAGNETICO STELO PASSANTE ANTIROTAZIONE
DOUBLE ACTING MAGNETIC ANTI-ROTATION WITH DOUBLE ROD

DIMENSIONI - DIMENSIONS									
Ø	020	025	032	040	050	063	080	100	125
A	16	16	19	19	22	22	28	28	40
AF	15	15	15	15	17	17	20	22	25
B2	5	5	6	6	7	7	8	8	9
Ø D	10	10	12	12	16	16	20	25	25
Ø D5	7,5	7,5	9	9	10,5	10,5	13,5	13,5	13,5
Ø D6	11	14	17	17	22	22	28	30	34
Ø D7	5	6	6	8	10	10	14	14	14
D8	M4	M5	M5	M5	M6	M6	M8	M10	M10
Ø D9	4	5	5	5	6	6	8	10	10
Ø D10	17	22	28	33	42	50	65	80	90
E	36	40	49	54,5	65,5	77,0	95,5	113,5	135
EE	M5	M5	G1/8	G1/8	G1/8	G1/8	G1/8	G1/8	G1/4
I9	-	-	10,8	12,8	21	25,8	30	50	50
I10	-	-	-	-	-	13	18	35	50
K	8	8	10	10	13	13	17	22	22
KF	M6	M6	M8	M8	M10	M10	M12	M12	M16
KK	M8	M8	M10x1,25	M10x1,25	M12x1,25	M12x1,25	M16x1,5	M16x1,5	M20x1,5
LA	4,5	4,5	5	5	5	5	3	3	-
L4	5	5	6,5	6,5	7,5	7,5	9	10	11,2
L5	1	1	1,5	1,5	1,5	1,5	2	3	2,2
PL	7,5	7,5	7,5	8	8	7,5	8	10,5	10,5
RT	M5	M5	M6	M6	M8	M8	M10	M10	M12
S1	8	8	10	10	12	12	14	14	18
SW2	13	13	17	17	19	19	24	24	30
TG	22	26	32,5	38	46,5	56,5	72	89	110
WH	6,5	6	6,5	7	8	8	9	10	11
WH+	6,5	6	6,5	7	8	8	9	10	11
ZA+	37	39	44	45	45	49	54	67	81
ZB+	43,5	45	50,5	52	53	57	63	77	92

+ = aggiungere lunghezza corsa (mm) - add stroke length (mm)

 Note: dado stelo compreso nella fornitura
 Note: rod nut included in the supply

Ø	CORSE STANDARD - STANDARD STROKES
020	5 - 10 - 15 - 20 - 25 - 30 - 40 - 50 - 60 - 70 - 75 - 80 - 90 - 100 - 125 - 160 - 200
025	5 - 10 - 15 - 20 - 25 - 30 - 40 - 50 - 60 - 70 - 75 - 80 - 90 - 100 - 125 - 160 - 200
032	5 - 10 - 15 - 20 - 25 - 30 - 40 - 50 - 60 - 70 - 75 - 80 - 90 - 100 - 125 - 160 - 200 - 250 - 300 - 350 - 400
040	5 - 10 - 15 - 20 - 25 - 30 - 40 - 50 - 60 - 70 - 75 - 80 - 90 - 100 - 125 - 160 - 200 - 250 - 300 - 350 - 400
050	5 - 10 - 15 - 20 - 25 - 30 - 40 - 50 - 60 - 70 - 75 - 80 - 90 - 100 - 125 - 160 - 200 - 250 - 300 - 350 - 400
063	5 - 10 - 15 - 20 - 25 - 30 - 40 - 50 - 60 - 70 - 75 - 80 - 90 - 100 - 125 - 160 - 200 - 250 - 300 - 350 - 400
080	5 - 10 - 15 - 20 - 25 - 30 - 40 - 50 - 60 - 70 - 75 - 80 - 90 - 100 - 125 - 160 - 200 - 250 - 300 - 350 - 400
100	5 - 10 - 15 - 20 - 25 - 30 - 40 - 50 - 60 - 70 - 75 - 80 - 90 - 100 - 125 - 160 - 200 - 250 - 300 - 350 - 400
125	5 - 10 - 15 - 20 - 25 - 30 - 40 - 50 - 60 - 70 - 75 - 80 - 90 - 100 - 125 - 160 - 200 - 250 - 300 - 350 - 400

DOPPIO EFFETTO MAGNETICO

DOUBLE ACTING MAGNETIC

SERIE
P

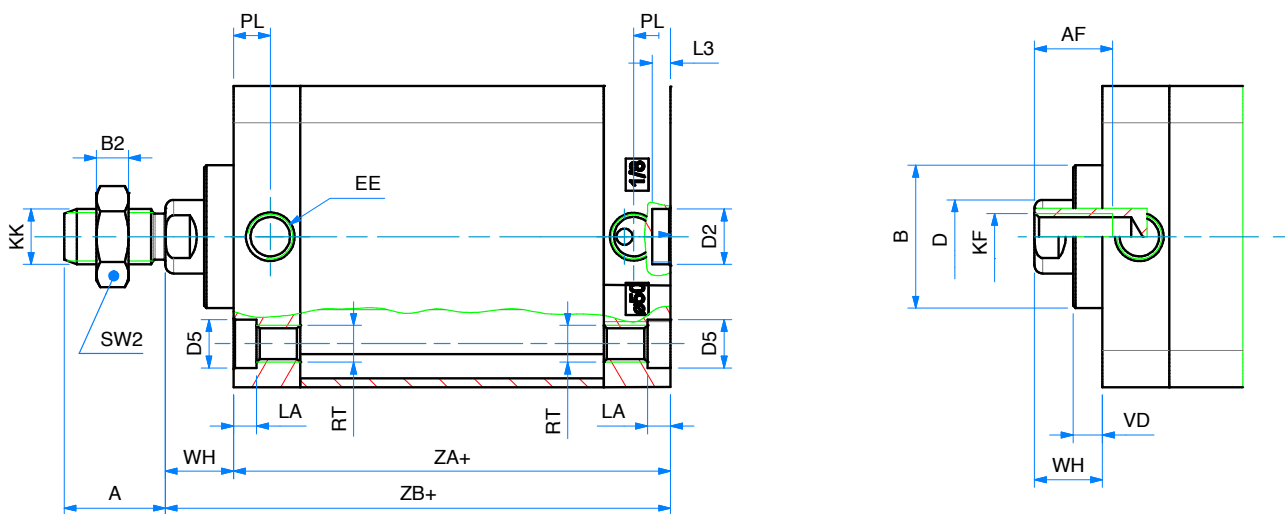
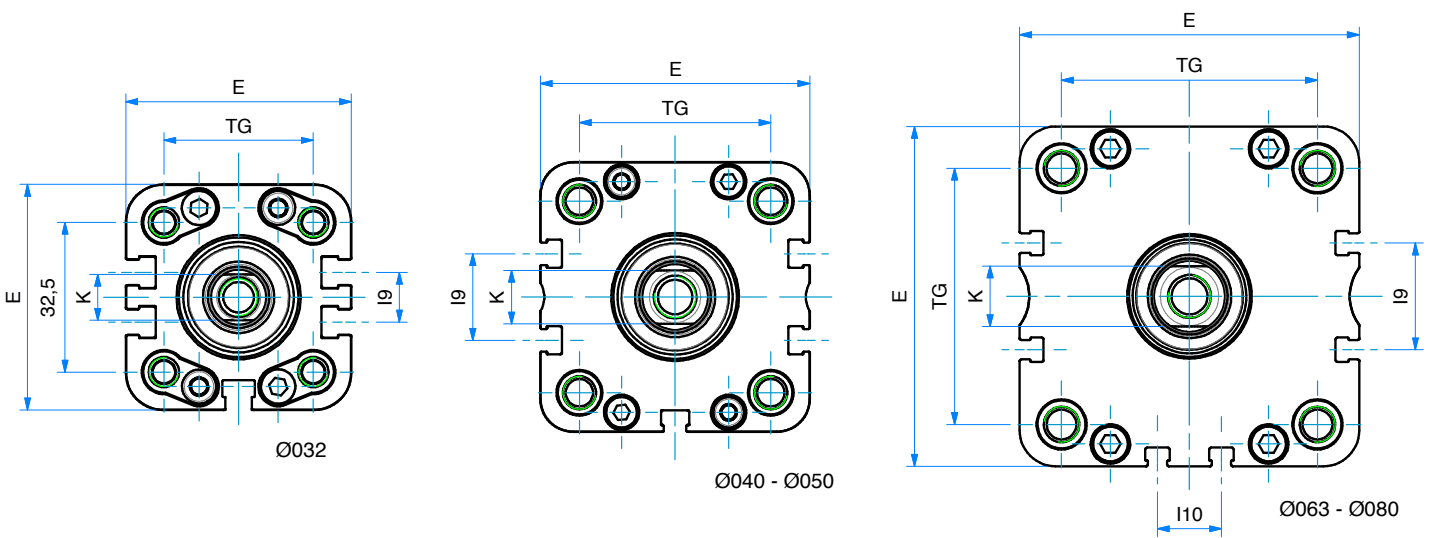
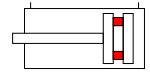

DOPPIO EFFETTO MAGNETICO
PDM-PS/ES/WS
DOUBLE ACTING MAGNETIC
DIMENSIONI - DIMENSIONS

Ø	032	040	050	063	080
A	19	19	22	22	28
AF	15	15	17	17	20
Ø B	27	27	31	31	35
B2	6	6	7	7	8
Ø D	12	12	16	16	20
Ø D2	9	9	12	12	12
Ø D5	9	9	10,5	10,5	13,5
E	49	54,5	65,5	77	95,5
EE	G1/8	G1/8	G1/8	G1/8	G1/8
I9	10,8	12,8	21	25,8	30
I10	-	-	-	13	18
K	10	10	13	13	17
KF	M8	M8	M10	M10	M12
KK	M10x1,25	M10x1,25	M12x1,25	M12x1,25	M16x1,5
LA	5	5	5,5	5	3
L3	3	3	4	4	4
PL	7,5	8	8	7,5	8
RT	M6	M6	M8	M8	M10
SW2	17	17	19	19	24
TG	32,5	38	46,5	56,5	72
VD	6,4	6,4	6,4	6,4	6,4
WH	12,5	12,5	14,8	14,6	15,4
ZA+	44	45	45	49	54
ZB+	56,5	57,5	59,7	63,6	69,4

+ = aggiungere lunghezza corsa (mm) - add stroke length (mm)

 Note: dado stelo compreso nella fornitura
 Note: rod nut included in the supply

Ø CORSE STANDARD - STANDARD STROKES

032	5 - 10 - 15 - 20 - 25 - 30 - 40 - 50 - 60 - 70 - 75 - 80 - 90 - 100 - 125 - 160 - 200 - 250 - 300 - 350 - 400
040	5 - 10 - 15 - 20 - 25 - 30 - 40 - 50 - 60 - 70 - 75 - 80 - 90 - 100 - 125 - 160 - 200 - 250 - 300 - 350 - 400
050	5 - 10 - 15 - 20 - 25 - 30 - 40 - 50 - 60 - 70 - 75 - 80 - 90 - 100 - 125 - 160 - 200 - 250 - 300 - 350 - 400
063	5 - 10 - 15 - 20 - 25 - 30 - 40 - 50 - 60 - 70 - 75 - 80 - 90 - 100 - 125 - 160 - 200 - 250 - 300 - 350 - 400
080	5 - 10 - 15 - 20 - 25 - 30 - 40 - 50 - 60 - 70 - 75 - 80 - 90 - 100 - 125 - 160 - 200 - 250 - 300 - 350 - 400

SERIE

P

DOPPIO EFFETTO MAGNETICO CON STELO FORATO
DOUBLE ACTING MAGNETIC WITH HOLLOW ROD

SERIE

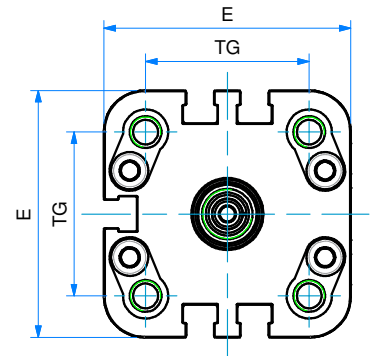
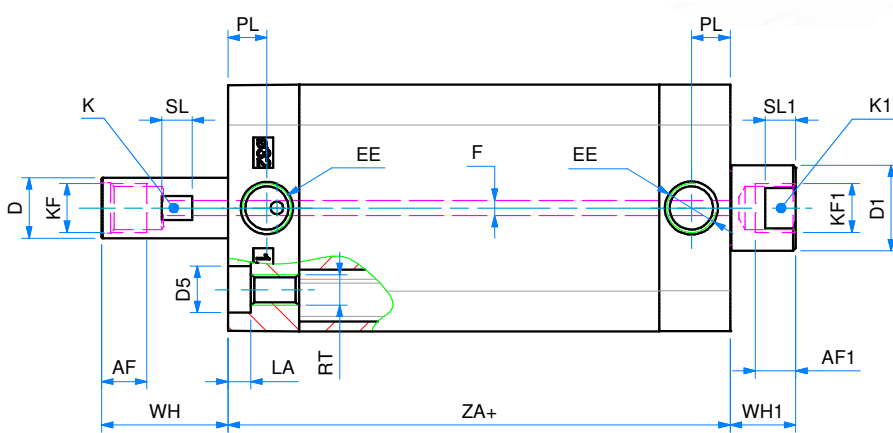
P

Note: stelo in acciaio inox 304 cromato

Note: chromed AISI 304 stainless steel rod

DIMENSIONI - DIMENSIONS

\emptyset	32
AF	9
AF1	7,5
$\emptyset D$	12
$\emptyset D1$	17
$\emptyset D5$	9
E	49
EE	G 1/8"
$\emptyset F$	3
K	11
K1	15
KF	G 1/8"
KF1	G 1/8"
LA	5
PL	7,5
RT	M6
SL	6
SL1	6
TG	32,5
WH	25
WH1	13
ZA+	50

 \emptyset CORSE STANDARD - STANDARD STROKES
032 50 - 100 - 150 - 200 - 250 - 300 - 350

+ = aggiungere lunghezza corsa (mm) - add stroke length (mm)

CILINDRI TANDEM - TANDEM CYLINDERS

CHIAVE DI CODIFICA - KEY CODE

P T2 M 0 6 3 . 1 0 0 . G S . M

VERSIONE - VERSION

- T2** tandem doppia spinta
double thrust tandem
- T3** tandem tripla spinta
3 x force
- T4** tandem quadrupla spinta
4 x force

OPZIONE - OPTION

EX ATEX II 2GD cT4

SERIE

P

P P M 0 5 0 . 0 3 0 . 0 8 0 . G S . F

ALESAGGIO BORE (Ø)

020 - 025 - 032 - 040
050 - 063 - 080 - 100 - 125

I° CORSA (mm) I° STROKE (mm)

vedere tabelle corse std
see std stroke tables

II° CORSA (mm) II° STROKE (mm)

vedere tabelle corse std
see std stroke tables

OPZIONE - OPTION

EX ATEX II 2GD cT4

VERSIONE - VERSION

M magnetico - *magnetic*

non magnetico - *non-magnetic*

VERSIONE - VERSION

- P** tandem più posizioni
multi position tandem
- C** tandem contrapposti posteriori
rear opposed tandem
- F** tandem contrapposti anteriori
front opposed tandem

SERIE - SERIES

- P** tubo profilato con cave per sensori
tube with slots for sensors

STELO - ROD

- F** femmina
female
- M** maschio
male

GUARNIZIONI - SEALS

- GS** guarnizioni standard
standard seals
- VR** guarnizione stelo per alte temperature
high temperature rod seal
- VA** tutte le guarnizioni per alte temperature
all seals for high temperature
- PS** guarnizione stelo EU P5600
EU P5600 rod seal
- ES** guarnizione stelo E8
E8 rod seal
- WS** guarnizione stelo EW (raschiatore metallico)
EW rod seal (metal scraper)

∅32 - 80
∅50 - 80

DOPPIA SPINTA - DOUBLE THRUST

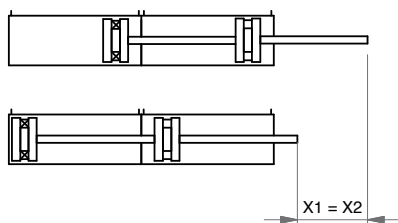

PIÙ POSIZIONI - MULTI-POSITIONS

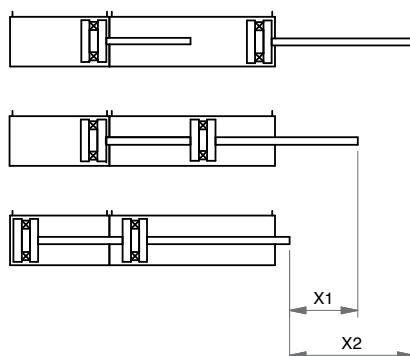

CONTRAPPOSTI POSTERIORI - REAR OPPOSED

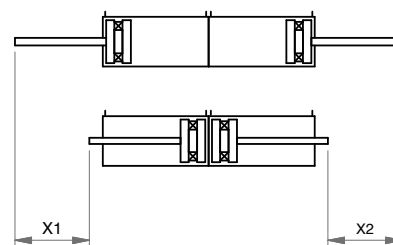

CONTRAPPOSTI ANTERIORI - FRONT OPPOSED

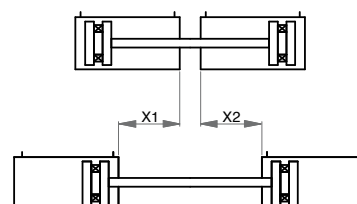

X1= 1° corsa - 1° stroke
X2= 2° corsa - 2° stroke

TANDEM DOPPIA SPINTA D.E.M.

DOUBLE THRUST TANDEM D.A.M.

SERIE
P

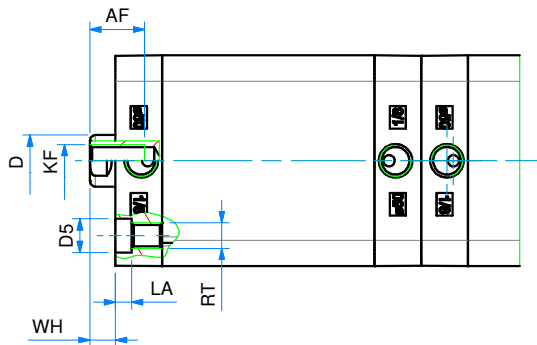
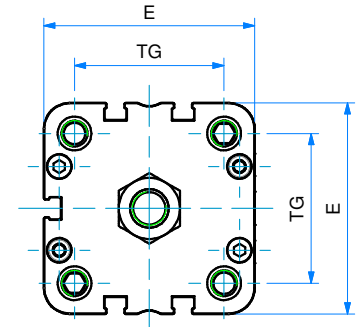
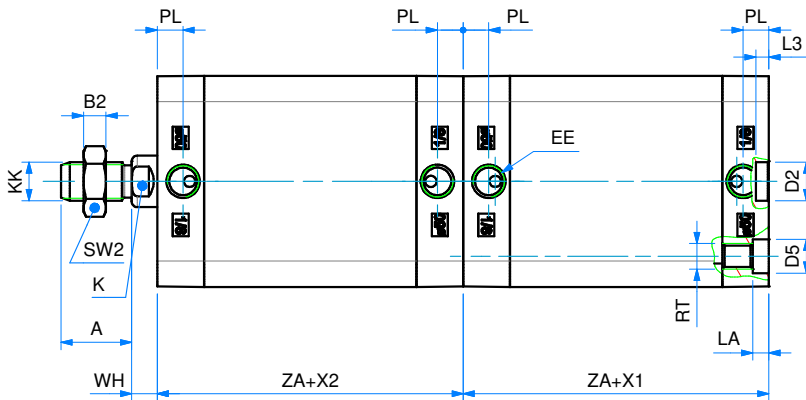
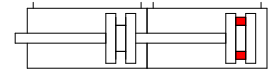

Note: dado stelo compresso nella fornitura
Note: rod nut included in the supply

DIMENSIONI - DIMENSIONS

ø	020	025	032	040	050	063	080	100	125
A	16	16	19	19	22	22	28	28	40
AF	15	15	15	15	17	17	20	22	25
B2	5	5	6	6	7	7	8	8	9
ø D	10	10	12	12	16	16	20	25	25
ø D2	9	9	9	9	12	12	12	12	12
ø D5	7,5	7,5	9	9	10,5	10,5	13,5	13,5	-
E	36	40	49	54,5	65,5	77	95,5	113,5	135
EE	M5	M5	G1/8	G1/8	G1/8	G1/8	G1/8	G1/8	G1/4
K	8	8	10	10	13	13	17	22	22
KF	M6	M6	M8	M8	M10	M10	M12	M12	M 16
KK	M8	M8	M10x1,25	M10x1,25	M12x1,25	M12x1,25	M16x1,5	M16x1,5	M 20x1,5
L3	3	3	3	3	4	4	4	4	4
LA	4,5	4,5	5	5	6,5	5	3	3	-
PL	7,5	7,5	7,5	8	8	7,5	8	10,5	10,5
RT	M5	M5	M6	M6	M8	M8	M10	M10	M12
SW2	13	13	17	17	19	19	24	24	30
TG	22	26	32,5	38	46,5	56,5	72	89	110
WH	6,5	6	6,5	7	8	8	9	10	11
X1	I° CORSA - I° STROKE								
X2	II° CORSA - II° STROKE								
ZA	37	39	44	45	45	49	54	67	81

TANDEM PIÙ POSIZIONI D.E.M.

PPM

MULTI-POSITION TANDEM D.A.M.

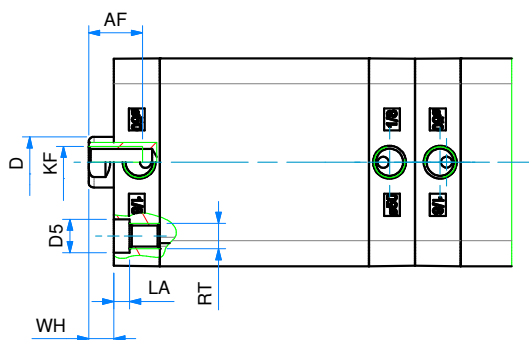
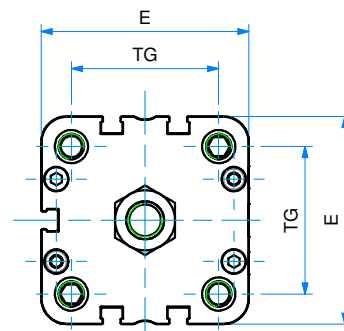
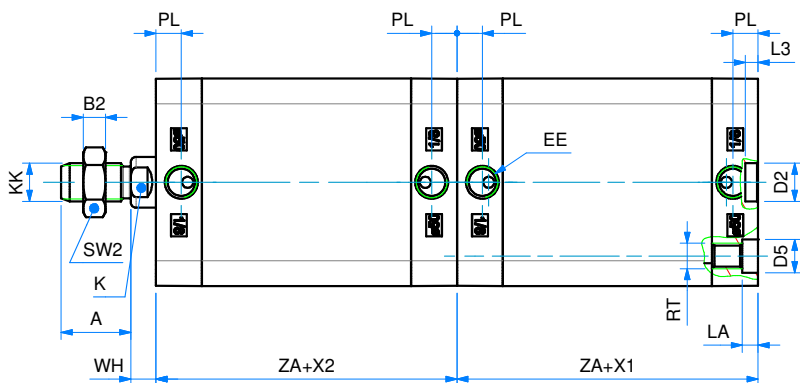
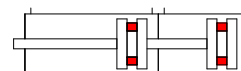
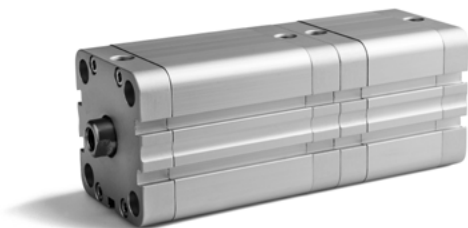

Note: dado stelo compreso nella fornitura
 Note: rod nut included in the supply

DIMENSIONI - DIMENSIONS

ø	020	025	032	040	050	063	080	100	125
A	16	16	19	19	22	22	28	28	40
AF	15	15	15	15	17	17	20	22	25
B2	5	5	6	6	7	7	8	8	9
ø D	10	10	12	12	16	16	20	25	25
ø D2	9	9	9	9	12	12	12	12	12
ø D5	7,5	7,5	9	9	10,5	10,5	13,5	13,5	-
E	36	40	49	54,5	65,5	77	95,5	113,5	135
EE	M5	M5	G1/8	G1/8	G1/8	G1/8	G1/8	G1/8	G1/4
K	8	8	10	10	13	13	17	22	22
KF	M6	M6	M8	M8	M10	M10	M12	M12	M 16
KK	M8	M8	M10x1,25	M10x1,25	M12x1,25	M12x1,25	M16x1,5	M16x1,5	M 20x1,5
L3	3	3	3	3	4	4	4	4	4
LA	4,5	4,5	5	5	6,5	5	3	3	-
PL	7,5	7,5	7,5	8	8	7,5	8	10,5	10,5
RT	M5	M5	M6	M6	M8	M8	M10	M10	M12
SW2	13	13	17	17	19	19	24	24	30
TG	22	26	32,5	38	46,5	56,5	72	89	110
WH	6,5	6	6,5	7	8	8	9	10	11
X1	I° CORSA - I° STROKE								
X2	II° CORSA - II° STROKE								
ZA	37	39	44	45	45	49	54	67	81

TANDEM CONTRAPPOSTI POSTERIORI D.E.M.

REAR OPPOSED TANDEM D.A.M.

SERIE
P

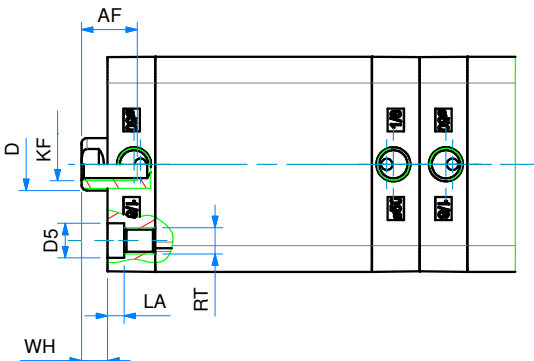
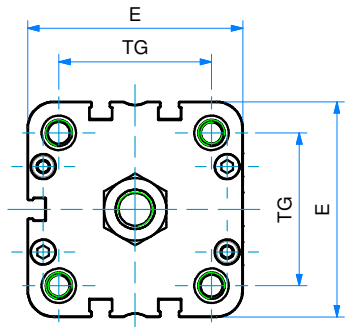
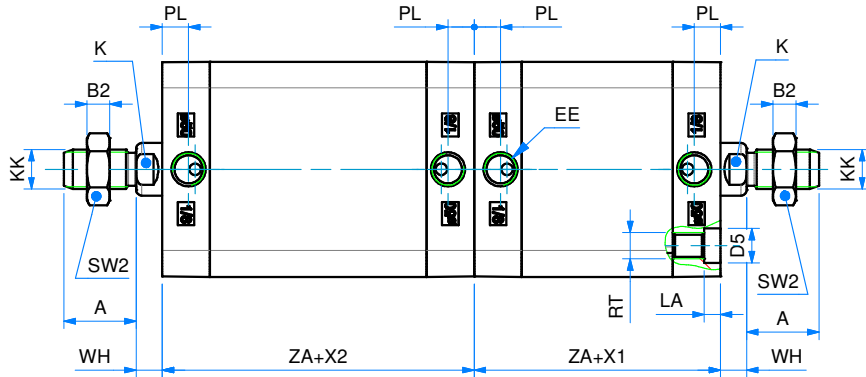
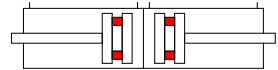

Note: dado stelo compreso nella fornitura
Note: rod nut included in the supply

DIMENSIONI - DIMENSIONS

ø	020	025	032	040	050	063	080	100	125
A	16	16	19	19	22	22	28	28	40
AF	15	15	15	15	17	17	20	22	25
B2	5	5	6	6	7	7	8	8	9
ø D	10	10	12	12	16	16	20	25	25
ø D2	9	9	9	9	12	12	12	12	12
ø D5	7,5	7,5	9	9	10,5	10,5	13,5	13,5	-
E	36	40	49	54,5	65,5	77	95,5	113,5	135
EE	M5	M5	G1/8	G1/8	G1/8	G1/8	G1/8	G1/8	G1/4
K	8	8	10	10	13	13	17	22	22
KF	M6	M6	M8	M8	M10	M10	M12	M12	M 16
KK	M8	M8	M10x1,25	M10x1,25	M12x1,25	M12x1,25	M16x1,5	M16x1,5	M 20x1,5
L3	3	3	3	3	4	4	4	4	4
LA	4,5	4,5	5	5	6,5	5	3	3	-
PL	7,5	7,5	7,5	8	8	7,5	8	10,5	10,5
RT	M5	M5	M6	M6	M8	M8	M10	M10	M12
SW2	13	13	17	17	19	19	24	24	30
TG	22	26	32,5	38	46,5	56,5	72	89	110
WH	6,5	6	6,5	7	8	8	9	10	11
X1	I° CORSA - I° STROKE								
X2	II° CORSA - II° STROKE								
ZA	37	39	44	45	45	49	54	67	81

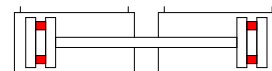
TANDEM CONTRAPPOSTI ANTERIORI D.E.M.
FRONT OPPOSED TANDEM D.A.M.

SERIE

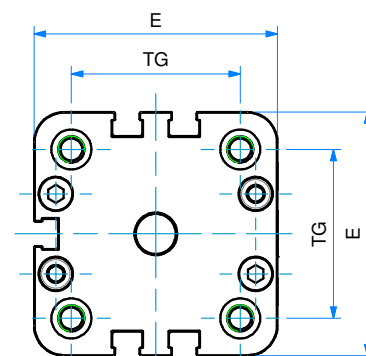
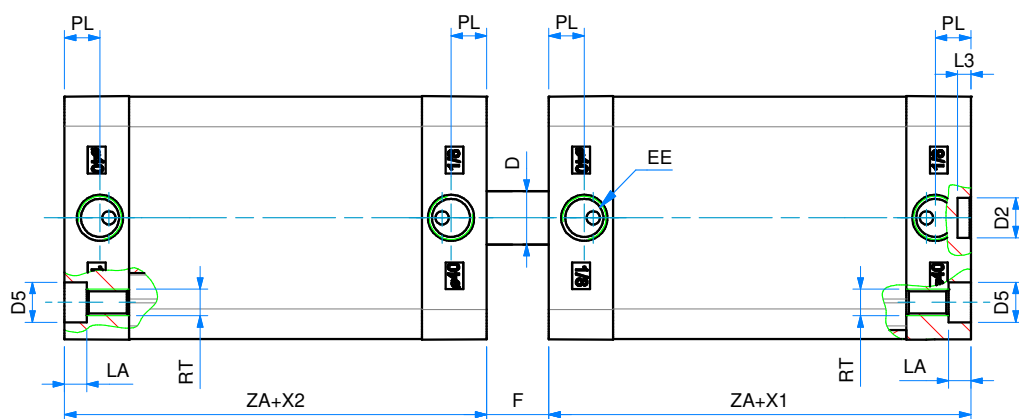
P

DIMENSIONI - DIMENSIONS

\varnothing	20	25	32	40	50	63	80	100	125
$\varnothing D$	10	10	12	12	16	16	20	25	25
$\varnothing D2$	9	9	9	9	12	12	12	12	12
$\varnothing D5$	7,5	7,5	9	9	10,5	10,5	13,5	13,5	-
E	36	40	49	54,5	65,5	77	95,5	113,5	135
EE	M5	M5	G1/8	G1/8	G1/8	G1/8	G1/8	G1/8	G1/4
F	13	12	13	14	16	16	18	20	22
L3	3	3	3	3	4	4	4	4	4
LA	4,5	4,5	5	5	5	5	3	3	-
PL	7,5	7,5	7,5	8	8	7,5	8	10,5	10,5
RT	M5	M5	M6	M6	M8	M8	M10	M10	M12
TG	22	26	32,5	38	46,5	56,5	72	89	110
X1	I° CORSA - I° STROKE								
X2	II° CORSA - II° STROKE								
ZA	37	39	44	45	45	49	54	67	81

ACCESSORI DI FISSAGGIO ISO 15552 (UTILIZZABILI ANCHE PER CILINDRI ISO 21287)

ISO 15552 MOUNTING PARTS (ALSO SUITABLE FOR ISO 21287 CYLINDERS)

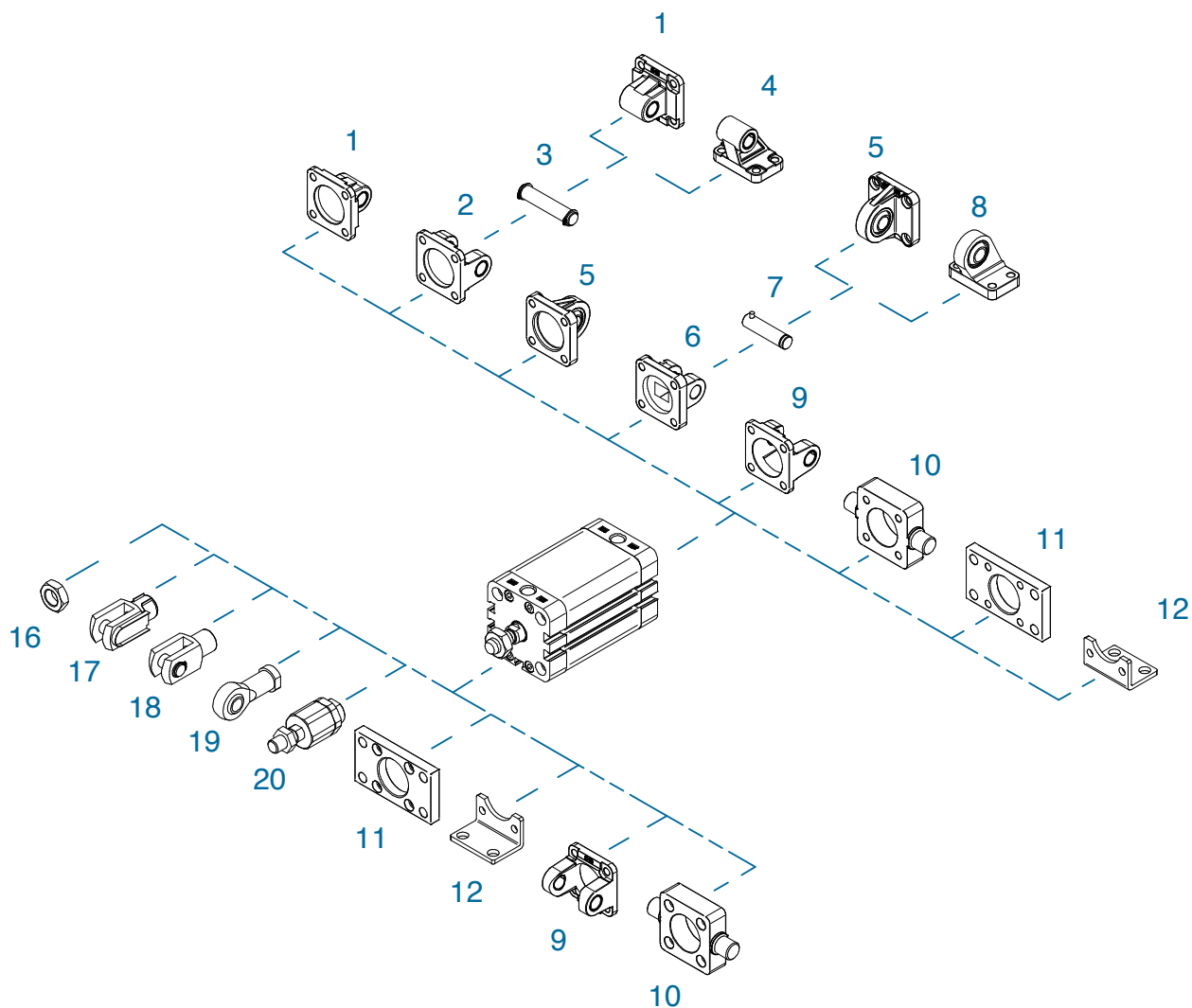
SERIE
P



POS.	CODE	DESCRIZIONE-DESCRIPTION
1	CMI---	cerniera maschio iso - iso male hinge
2	CFI---	cerniera femmina iso - iso female hinge
3	PCF---	perno per cerniera - pin for hinge
4	ASI---	articolazione a squadra iso - iso square hinge
5	CMSI---	cerniera maschio snodata iso iso male hinge with ball joint
6	CFSI---	cerniera femmina stretta iso iso narrow female hinge
7	PCFS---	perno per cerniera stretta pin for narrow hinge
8	ASSI---	articolazione a squadra snodata iso square hinge with ball joint
9	CFI---F	cerniera femmina forata iso hollow iso female hinge
10	CIA---	cerniera anteriore-posteriore lamata front-rear hinge
11	FI---	flangia iso - iso flange
12	PBI---	pedino basso iso - iso foot mounting

POS.	CODE	DESCRIZIONE-DESCRIPTION
16	DA--x--	dado - nut
17	FC--x--	forcella con clips - clevis with lockable pin
18	FP--x--	forcella con perno - clevis with pin
19	SSFI--x--	snodo sferico - rod eye
20	SA--x--	snodo autoallineante - self-aligning joint

Fissaggi forniti con viti - Mounting parts supplied with screws

Dimensioni accessori: vedi sezione SERIE W
Accessories dimensions: see SERIE W chapter